

- (A) Colector drenaje 2"
2" Drainage manifold
- (B) Colector entrada 14"
14" Inlet manifold
- (C) Colector salida 14"
14" Outlet manifold

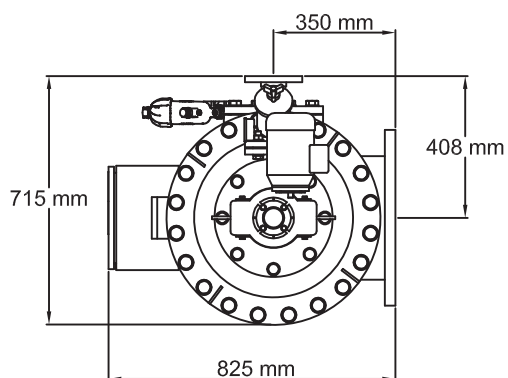

AZUD LUXON LDB 10600 S/14

SCALE S/E A4 FORMAT	MATERIAL:	RESPONS.: M. Martínez	AZUD
	UNITS: mm.	REVISION: 00	
	FILE: Azud_luxon_LDB_10600-S14.dwg	04/05/2012	